

Function Introduction

Lonqi New Energy Technology has developed LONQ-40 DC series new energy disconnect switches through years of dedicated research on the operation of new energy systems at home and abroad and the needs of customers.

Product Features

- Quickly isolate circuits to ensure the safety of electricity consumption.
- Maximum rated voltage DC 1500V, maximum current 32A.
- Waterproof to IP66 for outdoor use.
- Equipped with M20 waterproof two-hole connector, you can DIY design 1 or 2 strings connection according to your needs.
- Mounting holes are reserved at the top and bottom of the housing, eliminating the need to drill holes to damage the housing and making installation quick.

Model Name Meaning



Certification



EU IPO



TUV



CB



UKCA

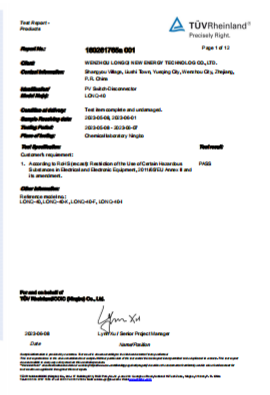

ROHS

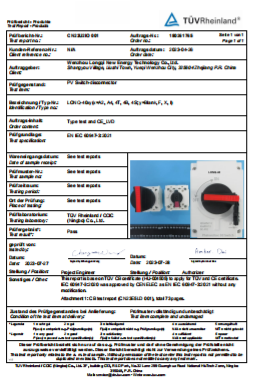

CE



AZ



CCC



GTS



Patent

Main Technical Parameter

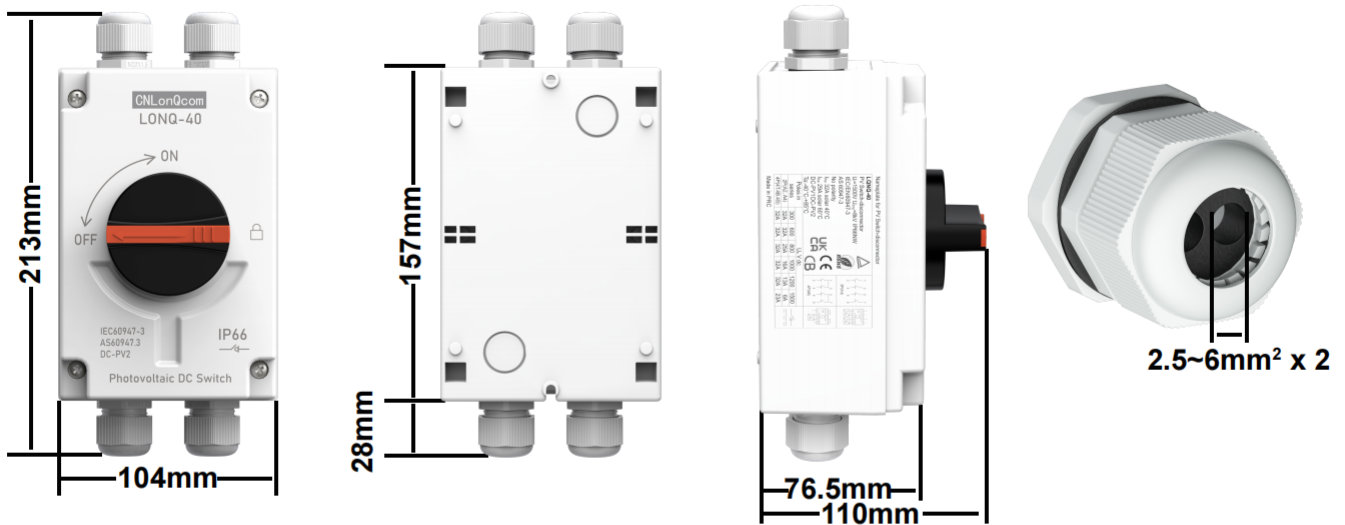

Technical Data						
Model	LONQ-40-M20					
Type	PV DC Disconnect Isolator Switch					
String	2 in 2 out or 2 in 1 out or 1 in 1 out or 1 in 2 out					
Rated Current In(A)	32	32	32	32	32	23
Rated Working Voltage Ue (V)	300	600	800	1000	1200	1500
Rated Insulation Voltage Ui (V)	1500V					
Pole	4P					
Rated Impulse Withstand Voltage Uimp (kV)	8					
Short-Time Withstand Current Icw (kA)	1					
Standard	IEC/EN60947-3 GB/T 14048.3					
Insolation Feature	Yes					
Levels of Protection	IP66					
Housing Material	PC					
Conductor Material	Copper					
Quality Certificate	TUV, CE, CB, UKCA, AZ, CCC, ISO9001, ROHS					
Mechanical Life (times)	20000					
Electrical Life (times)	6000					
Knob Positions	OFF at 9 hr , ON at 12 hr					
Operating Temperature	-40°C to +85°C					
Humidity	95%					
Altitude	2000m					
Installation	Wall Mounting					

Size and Weight



Size and Weight

Product Size (mm)	213*104*110
Product Weight (kg)	0.672
Individual Package Size (mm)	160*110*115
Individual Package Weight (kg)	0.825
Packaging Details	1Pcs per inner box, 20Pcs per carton
Outer Box Size(cm)	575*340*260
Outer Box Weight(kg)	17.475

Product Details

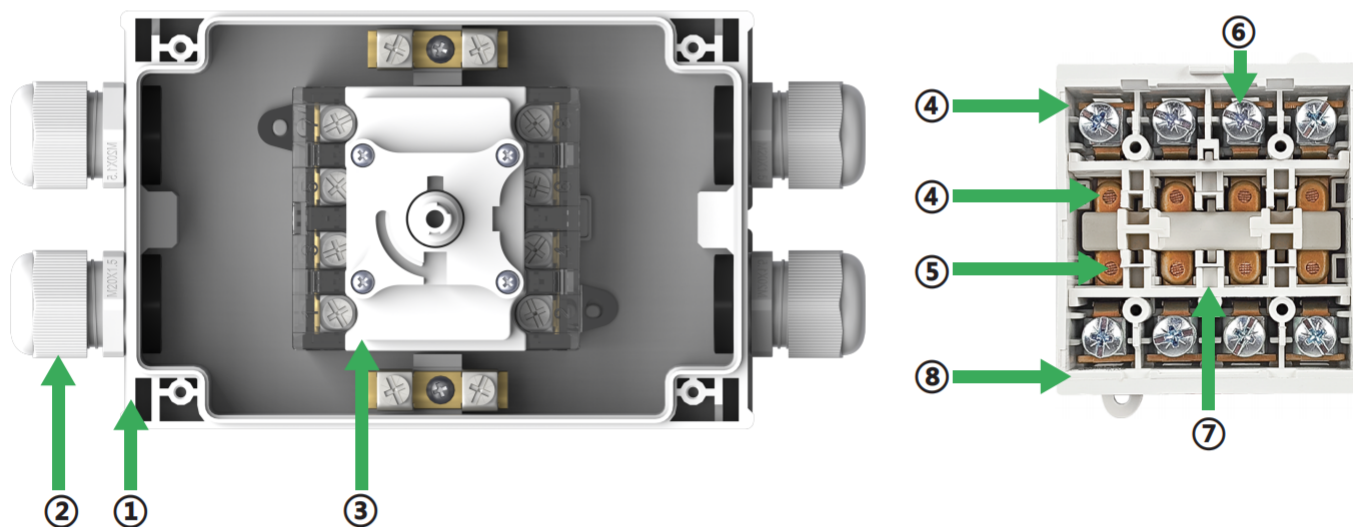

- ① **PC shell:** high strength, drop-resistant and durable
- ② **PG Series M20 Connector:** IP68 waterproof, recommended to use 2.5~6mm² cable
- ③ **Isolator:** EU TUV and CE certified
- ④ **Thick Copper Conductor:** Low resistance and low heat generation
- ⑤ **Silver Plated Contacts:** Anti-oxidation
- ⑥ **Corrosion Resistant Screws:** Salt Spray Tested
- ⑦ **Magnet:** Fast arc extinguishing
- ⑧ **PA Housing:** UL94V-0 flame retardant grade

Contact Wiring Diagram

Contact Wiring Diagram			
Connect Method Code	Circuit Type	Wiring Diagram	Load Diagram
2P(A2)	2 poles in series for one string, 1 load		
2P(A4)	2 poles in series for one string, total 2 loads		
4P(4T)	4 poles in series, for one string		
4P(4B)	4 poles in series, for one string		
4P(4S)	4 poles in series, for one string		

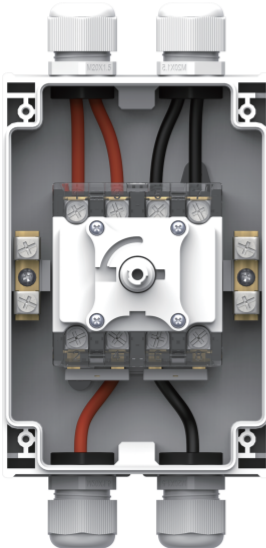

2 in 1out

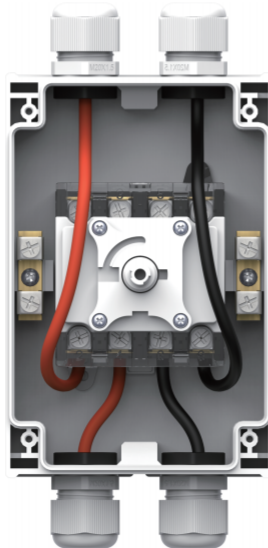

1 in 1out

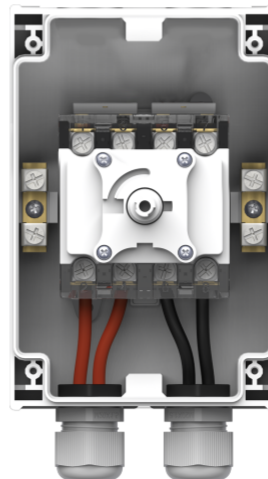

1 in 1out

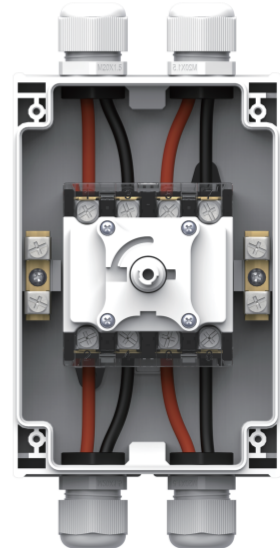

2 in 2out

M20 Connector Installation

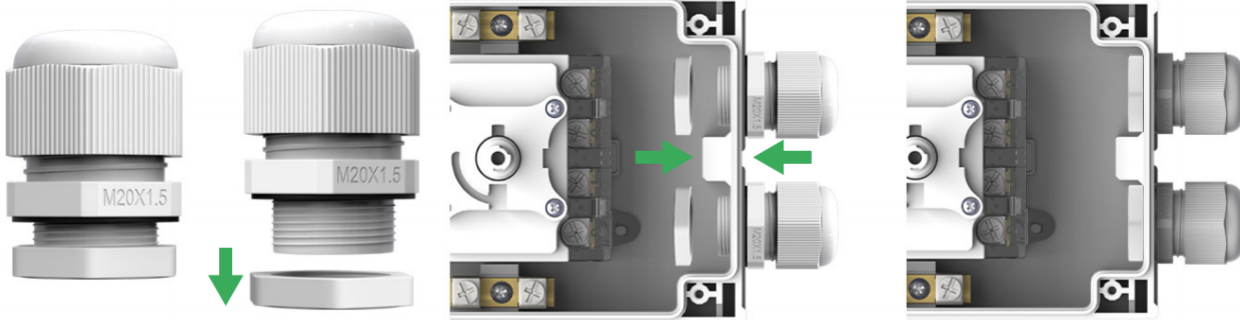
**① Splitting the M20**

Remove the retaining ring from M20 by rotating it.

② Align an aperture

Place the retaining ring on the inside of the switch and the M20 on the outside partially through the hole.

③ Tighten

Splice and screw them together.

Wall Mount

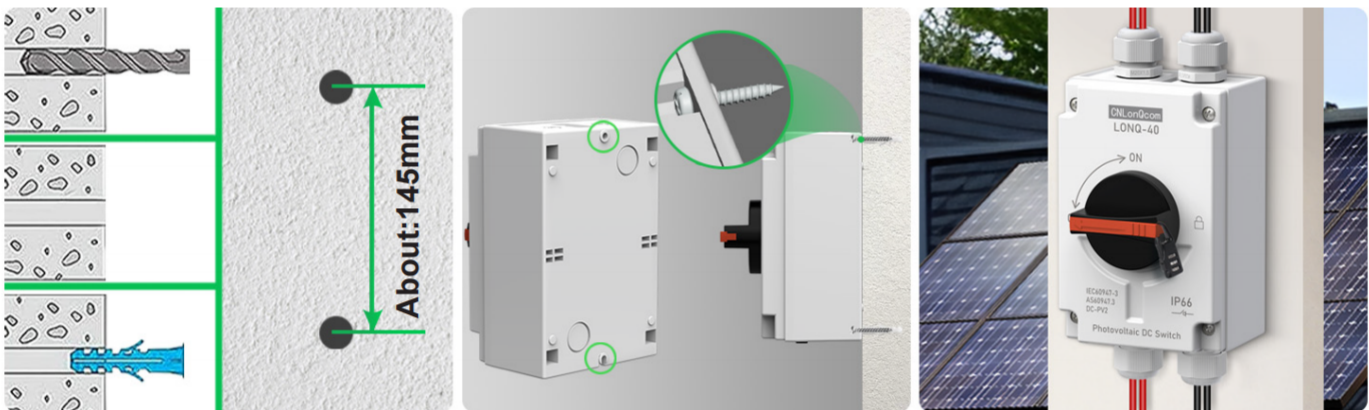
**① Perforation**

Use a drill bit to cut holes in the wall at appropriate locations and insert expansion tubes.

② Mounting

Screw into the pre-drilled holes at the top and bottom of the box.

③ Connect Wire

Connect the PV cables and complete the installation of the PV protection system.

Tip:

① Please disconnect the power supply when installing the wiring, it is better to ask professional electricians to install.

② The wiring of the disconnect switch must be correct and reliable to prevent poor contact, short circuit and other phenomena. During the wiring process, appropriate wire diameter and wiring method should be used to ensure firm and reliable wiring.

Supplied with Accessories

① Expansion Tube*4

Put into the wall holes to make the screws more secure when they go in

② Mounting Screw*4

Corrosion-resistant, passes 48-hour salt spray test, Phillips screwdriver recommended for mounting



③ M20 Connector and Waterproof Plug*4

IP68 waterproof, flexible installation, optional single connector for 2- or 1-strand cables



④ Blade Terminal*8(optional)

Combination of insulating rubber and tinned copper conductors for safer and stronger wiring. Low resistance, anti-oxidation



⑤ Combination Lock

This lock is set to open at '000' during production. You can customise the reset to a new combination.

To reset your password:

1. Rotate the passcode to the correct position, then press and hold the bottom round button (1).
2. Turn the passcode to change it to the desired password and finally release the button (1).



Lock Installation

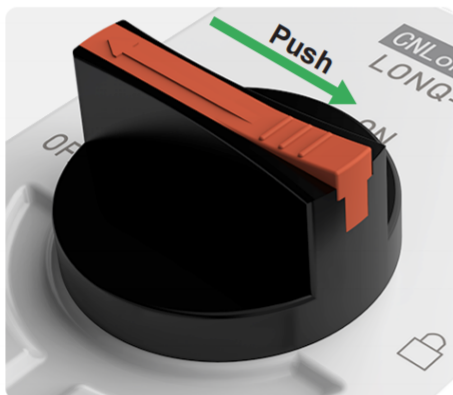

① Push Handle

Push the red part above the handle to the right to expose the hole.



② Mounting

Snap the combination lock into the hole

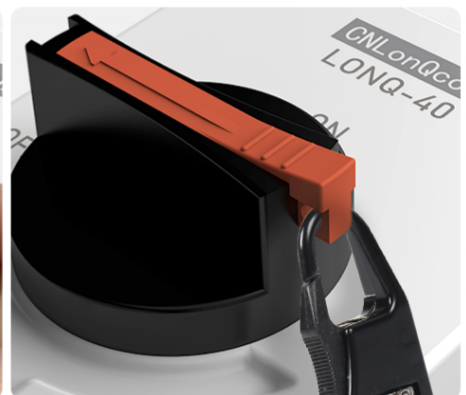

③ Rotary Code Dial

Installation complete. Mess up the password.

Complete Solutions for The Protection of PV Systems

① PV Connector Series ② PV Disconnect Switch ③ PV Combiner Box

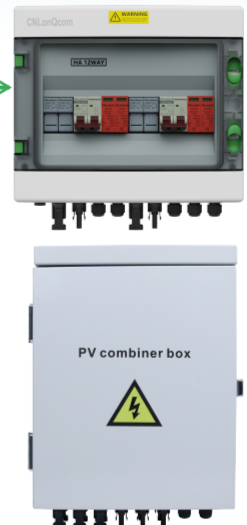

Complete Solutions for The Protection of AC Systems

④ Battery Protection Box

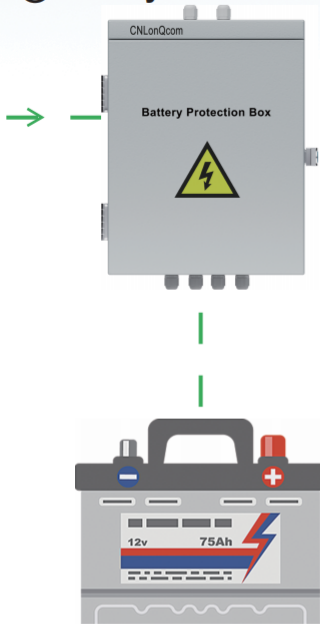

Inverter

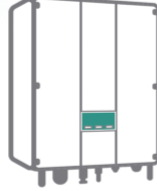

⑤ AC Combiner Box

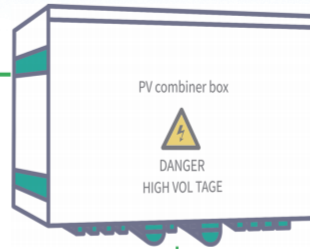

AC Load

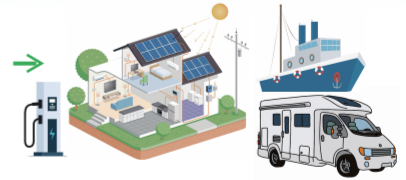

Battery Pack

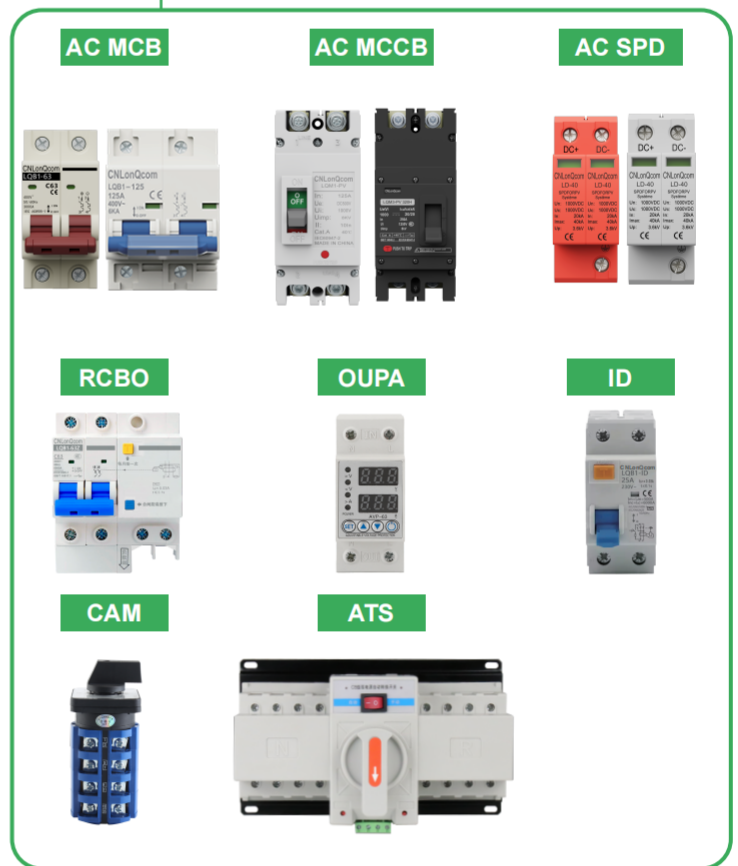

WELCOME TO BECOME OUR AGENT
We will provide our agents with:

1. More favourable price
2. Exhibition/sales channels
3. Area price protection
4. OEM/ODM support
5. Technical & Accessories Support
6. Annual sales target rebate

For more DC and AC circuit protection products please contact us!



Contact phone number:

+86 133-5331-9123



Contact Email:

sales@cnlonq.com



Company Address:

No.76, Jingyou 7 Road, Upstream Industrial Zone, Liu Shi Town, Yueqing City, Wenzhou City, Zhejiang Province, China.